



Metric Hydraulic Hose Fittings Index

CRIMP FERRULES

<p>SAE 100R1A Hose Skive Type Page 1</p>	<p>SAE 100R2 Skive Type Page 1</p>	<p>SAE 100R1T / R2AT No Skive Page 1</p>	<p>SAE 100R7 / R8 No Skive Page 1</p>	<p>SS Braided Teflon Smooth Bore Hose Page 1</p>	<p>SS Braided Teflon Convoluted Bore Page 1</p>

BRITISH STANDARD PIPE (BSP)

<p>British Standard Pipe (BSP) Male 60° Cone Page 2</p>	<p>British Standard Pipe (BSP) Male Flat Seat Page 2</p>	<p>British Standard Pipe Male Tapered (BSPT) Page 2</p>	<p>British Standard Pipe (BSP) Swivel Female Page 3</p>	<p>British Standard Pipe Flat Seat Swivel Female Page 3</p>
<p>British Standard Pipe Swivel Female 45° Elbow Page 4</p>	<p>British Standard Pipe Swivel Female 90° Elbow Page 4</p>	<p>British Standard Pipe Female Swivel with O-ring Page 5</p>	<p>British Standard Pipe 45° Elbow with O-ring Page 5</p>	<p>British Standard Pipe 90° Elbow with O-ring Page 5</p>

DIN 2353 METRIC : L-SERIES

<p>Metric Standpipe Straight Page 6</p>	<p>Metric Standpipe 45° Elbow Page 6</p>	<p>Metric Standpipe 90° Elbow Page 6</p>	
<p>L Series Male Page 7</p>	<p>L Series Female Swivel Straight with O-ring Page 7</p>	<p>L Series Female Swivel 45° Elbow with O-ring Page 7</p>	<p>L Series Female Swivel 90° Elbow with O-ring Page 7</p>



Metric Hydraulic Hose Fittings Index

DIN 2353 METRIC : S-SERIES

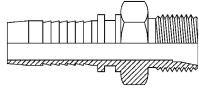

S Series Male
Page 8

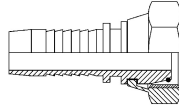

S Series Female Swivel
Straight with O-ring
Page 8

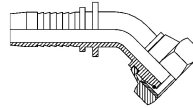

S Series Female Swivel
45° Elbow with O-ring
Page 8

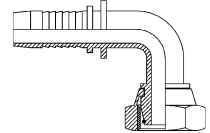

S Series Female Swivel
90° Elbow with O-ring
Page 8

60° CONE METRIC

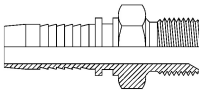

Metric Male
Page 9

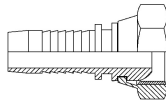

Female Swivel
60° Cone Seat
Page 9

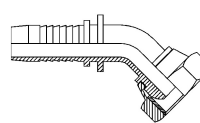

Female Swivel 45° Elbow
60° Cone Seat
Page 10

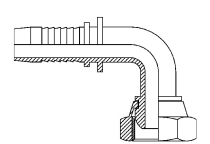

Female Swivel 90° Elbow
60° Cone Seat
Page 10

JIC - SAE 37° FLARE

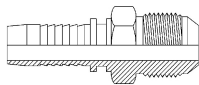

JIC Male
Page 11

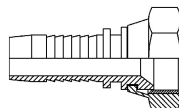

JIC Female Swivel
Page 11

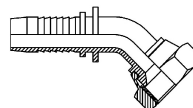

JIC Female Swivel 45° Elbow
Page 12

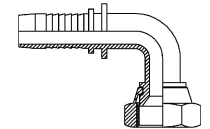

JIC Female Swivel 90° Elbow
Page 12

SAE CODE 61 FLANGE

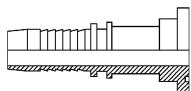

Code 61 Flange Straight
Page 13

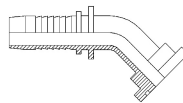

Code 61 Flange
45° Elbow
Page 13

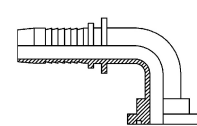

Code 61 Flange
90° Elbow
Page 13



Metric Hydraulic Hose Fittings Index

SAE CODE 62 FLANGE

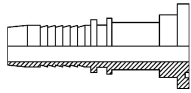

Code 62 Flange Straight
Page 14

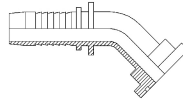

Code 62 Flange
45° Elbow
Page 14

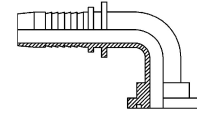

Code 62 Flange
90° Elbow
Page 14

MISCELLANEOUS METRIC HOSE FITTINGS

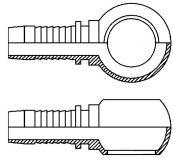

Banjo Hose Fitting
Page 15

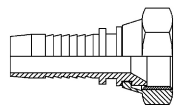

JIS Female Swivel 30°
Flare Seat
Page 15

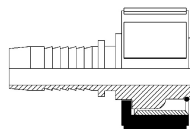

Pressure Washer
Page 15

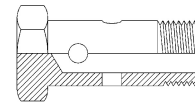

Hollow Bolt for Banjo Hose
Fittings
Pages 16

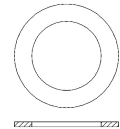

Copper Washer for Banjo
Hose Fittings
Page 16

INTERLOCK HOSE FITTINGS

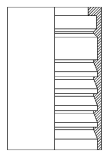

Interlock Crimp Ferrule 4SH Hose
Internal & External Skive
Page 17



Interlock Crimp Ferrule 100R13 Hose
Internal & External Skive
Page 17

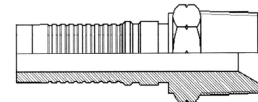

Male NPT Interlock
Page 17

INTERLOCK BSPB HOSE FITTINGS

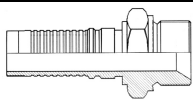

Interlock BSPB Male
Page 18

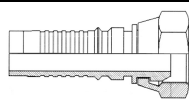

Interlock BSP Female Swivel
Page 18

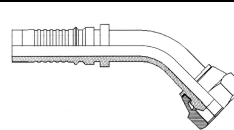

Interlock BSP Female Swivel
45° Elbow
Page 18

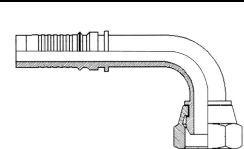

Interlock BSP Female Swivel
90° Elbow
Page 18



Metric Hydraulic Hose Fittings Index

INTERLOCK DIN 2353 HOSE FITTINGS

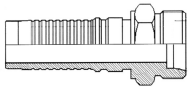

Interlock S Series Male
Page 19

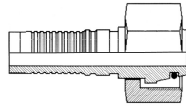

Interlock S Series Female Swivel
Page 19

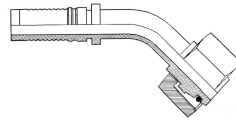

Interlock S Series Female Swivel
45° Elbow
Page 19

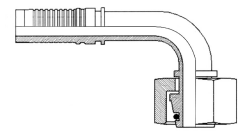

Interlock S Series Female Swivel
90° Elbow
Page 19

INTERLOCK JIC HOSE FITTINGS

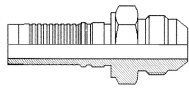

Interlock JIC Male
Page 20

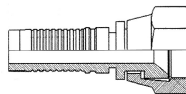

Interlock JIC Female Swivel
Page 20

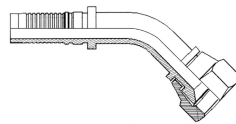

Interlock JIC Female Swivel
45° Elbow
Page 20

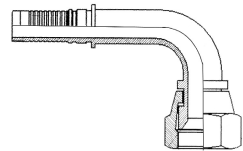

Interlock JIC Female Swivel
90° Elbow
Page 20

INTERLOCK SAE FLANGE

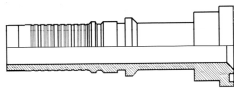

Interlock Code 61 Flange Straight
Page 21

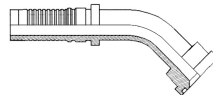

Interlock Code 61 Flange
45° Elbow
Page 21

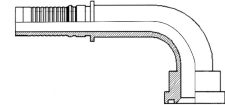

Interlock Code 61 Flange
90° Elbow
Page 21

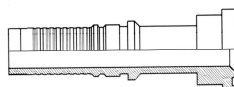

Interlock Code 62 Flange Straight
Page 22

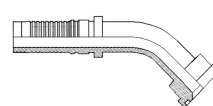

Interlock Code 62 Flange
45° Elbow
Page 22

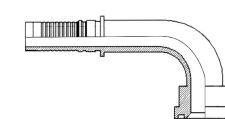

Interlock Code 62 Flange
90° Elbow
Page 22

RE-USEABLE HOSE FITTINGS - VARIOUS

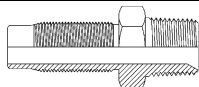

Re-useable Male Various
Page 23

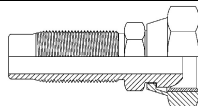

Re-useable Female Various
Page 23

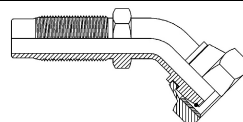

Re-useable Female Swivel 45°
Page 23

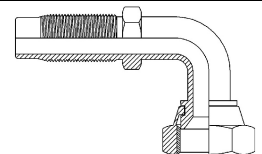







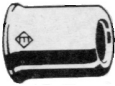

Re-useable Female Swivel 90°
Page 23

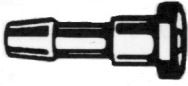
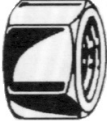
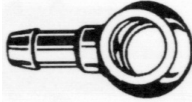

Metric Hydraulic Hose Fittings Index

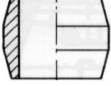

LOW PRESSURE HOSE & FITTINGS

 <p>Low Pressure Hose Steel or SS Braided Page 24</p>	 <p>Crimp Sleeves For Low Pressure Hose Page 25</p>	 <p>Cone Seat Hose Barb For Metric or BSP Threaded Nuts Page 26</p>	 <p>Flat Seat Hose Barb For Metric or BSP Threaded Nuts Page 26</p>
 <p>Nut for Hose Barb Metric or BSP Thread Page 26</p>	 <p>Single Hose Barb Banjo For Metric or BSP Bolt Page 26</p>	 <p>Double Hose Barb Banjo For Metric or BSP Bolt Page 27</p>	 <p>Metric Standpipe Hose Barb Straight, 45° and 90° Page 27</p>
 <p>Male Metric Hose Barb Metric or BSP Thread Page 27</p>	 <p>Brass Olive For Metric Plastic Tube Page 28</p>	 <p>Brass Reinforcing Insert For Metric Plastic Tube Page 28</p>	 <p>Grease Nipple Metric or BSP Thread Page 28</p>

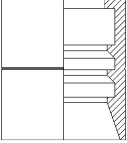
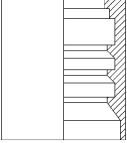
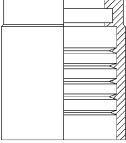
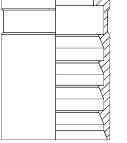
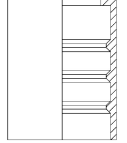
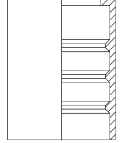
STAINLESS STEEL CRIMP FERRULES

 <p>SAE 100R1A Hose Skive Type Page 29</p>	 <p>SAE 100R2 Skive Type Page 29</p>	 <p>SAE 100R1T / R2AT No Skive Page 29</p>	 <p>SAE 100R7 / R8 No Skive Page 29</p>	 <p>SS Braided Teflon Smooth Bore Hose Page 30</p>	 <p>SS Braided Teflon Convoluted Bore Page 30</p>
---	---	---	---	---	--

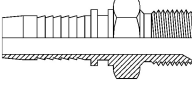
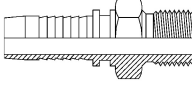
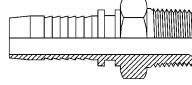
STAINLESS STEEL BSP & NPT MALE

 <p>British Standard Pipe (BSP) Male 60° Cone Page 31</p>	 <p>British Standard Pipe (BSP) Male Flat Seat Page 31</p>	 <p>British Standard Pipe Male Tapered (BSPT) Page 32</p>	 <p>National Pipe Thread Male (NPT) Page 32</p>
--	---	---	--



Metric Hydraulic Hose Fittings Index

STAINLESS STEEL BRITISH STANDARD PIPE (BSP)

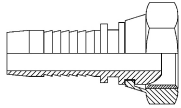

British Standard Pipe (BSP) Swivel Female
Page 33

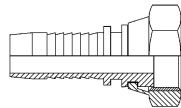

British Standard Pipe Flat Seat Swivel Female
Page 33

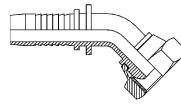

British Standard Pipe Swivel Female 45° Elbow
Page 34

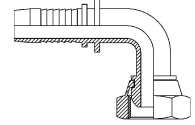

British Standard Pipe Swivel Female 90° Elbow
Page 34

STAINLESS STEEL METRIC STANDPIPES

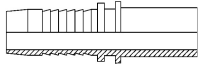

Metric Standpipe Straight
Page 35

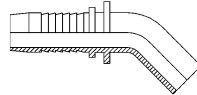

Metric Standpipe 45° Elbow
Page 35

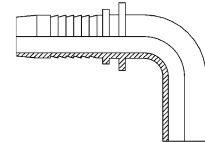

Metric Standpipe 90° Elbow
Page 35

STAINLESS STEEL DIN 2353 METRIC : L-SERIES

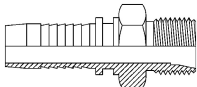

L Series Male
Page 36

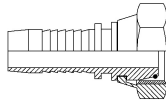

L Series Female Swivel Straight with O-ring
Page 36

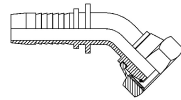

L Series Female Swivel 45° Elbow with O-ring
Page 37

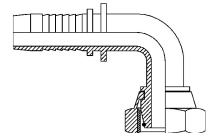

L Series Female Swivel 90° Elbow with O-ring
Page 37

STAINLESS STEEL DIN 2353 METRIC : S-SERIES

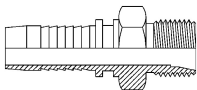

S Series Male
Page 38

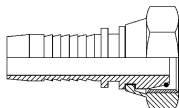

S Series Female Swivel Straight with O-ring
Page 38

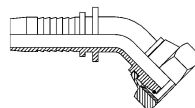

S Series Female Swivel 45° Elbow with O-ring
Page 38

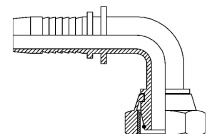

S Series Female Swivel 90° Elbow with O-ring
Page 38



Metric Hydraulic Hose Fittings Index

STAINLESS STEEL JIC - SAE 37° FLARE

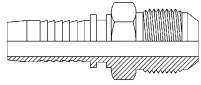

JIC Male
Page 39

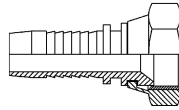

JIC Female Swivel
Page 39

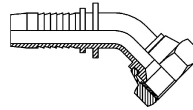

JIC Female Swivel 45° Elbow
Page 40

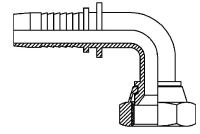

JIC Female Swivel 90° Elbow
Page 40

STAINLESS STEEL SAE CODE 61 FLANGE

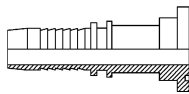

Code 61 Flange Straight
Page 41

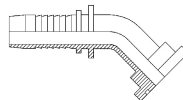

Code 61 Flange
45° Elbow
Page 41

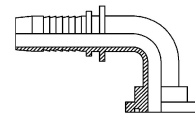

Code 61 Flange
90° Elbow
Page 41

STAINLESS STEEL SAE CODE 62 FLANGE

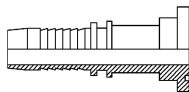

Code 62 Flange Straight
Page 42

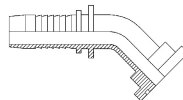

Code 62 Flange
45° Elbow
Page 42

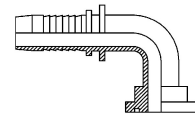

Code 62 Flange
90° Elbow
Page 42

MISCELLANEOUS STAINLESS METRIC HOSE FITTINGS

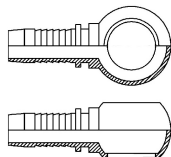

Banjo Hose Fitting
Page 43

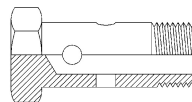

Hollow Bolt for Banjo Hose Fittings
Pages 43

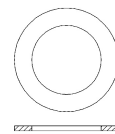

Copper Washer for Banjo Hose Fittings
Page 16



Metric Hydraulic Hose Fittings Index

STAINLESS STEEL INTERLOCK HOSE FITTINGS

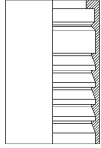

Interlock Crimp Ferrule 4SH Hose
Internal & External Skive
Page 44

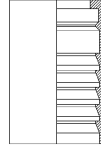

Interlock Crimp Ferrule 100R13 Hose
Internal & External Skive
Page 44

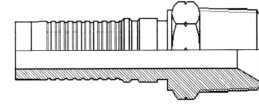

Male NPT Interlock
Page 44

STAINLESS STEEL INTERLOCK BSP HOSE FITTINGS

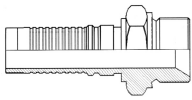

Interlock BSPP Male
Page 45

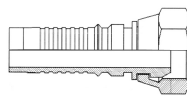

Interlock BSP Female Swivel
Page 45

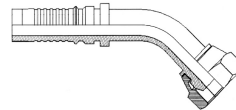

Interlock BSP Female Swivel
45° Elbow
Page 45

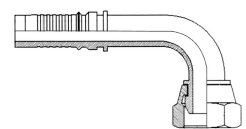

Interlock BSP Female Swivel
90° Elbow
Page 45

STAINLESS STEEL INTERLOCK DIN 2353 HOSE FITTINGS

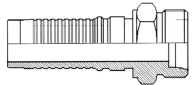

Interlock S Series Male
Page 46

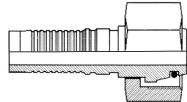

Interlock S Series Female Swivel
Page 46

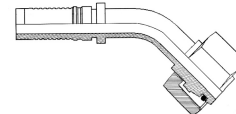

Interlock S Series Female Swivel
45° Elbow
Page 46

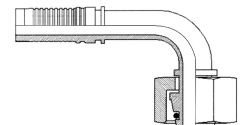

Interlock S Series Female Swivel
90° Elbow
Page 46

STAINLESS STEEL INTERLOCK JIC HOSE FITTINGS

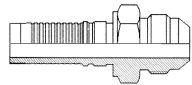

Interlock JIC Male
Page 47

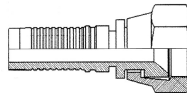

Interlock JIC Female Swivel
Page 47

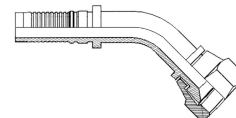

Interlock JIC Female Swivel
45° Elbow
Page 47

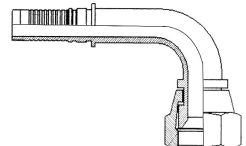

Interlock JIC Female Swivel
90° Elbow
Page 47



Metric Hydraulic Hose Fittings Index

STAINLESS STEEL INTERLOCK SAE FLANGE

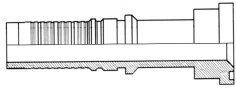

Interlock Code 61 Flange Straight
Page 48

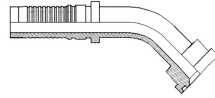

Interlock Code 61 Flange
45° Elbow
Page 48

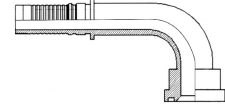

Interlock Code 61 Flange
90° Elbow
Page 48

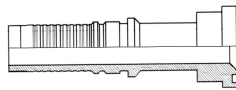

Interlock Code 62 Flange Straight
Page 49

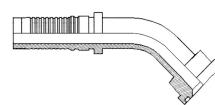

Interlock Code 62 Flange
45° Elbow
Page 49

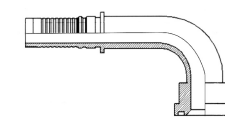

Interlock Code 62 Flange
90° Elbow
Page 49